

PANI JUREK

Technical Data Sheet / Lighting TRN



A fascination with Jan Tarasin paintings and graphics was a starting point for the creation of the whole collection. Tarasin was interested in the world of objects. He began with realistic record objects that he simplified and reduced until a system of abstract signs was formed. In her latest collection, Pani Jurek reverses this process, turning ideograms into things again. Her three dimensional objects have a simple calligraphic form so they can play and talk together as if they were letters from a non-existent alphabet.

There are 5 models of side tables in the collection, 8 types of mirrors and ceramic lighting fixtures, whose single elements can be arranged into the compositions. The hand crafted process of glazing ceramics and furniture making gives the collection a truly unique character. Each piece is one of a kind.

Figure 1. The dimensions of an example F2 model from TRN collection. The brass extension between the lamp and the ceiling cup allows you to adjust the height of the lamp according to your design.

Figure 1b. The close-up and cross-section of the ceiling cup illustrating how the extension tube enters inside the brass cone of the cup.

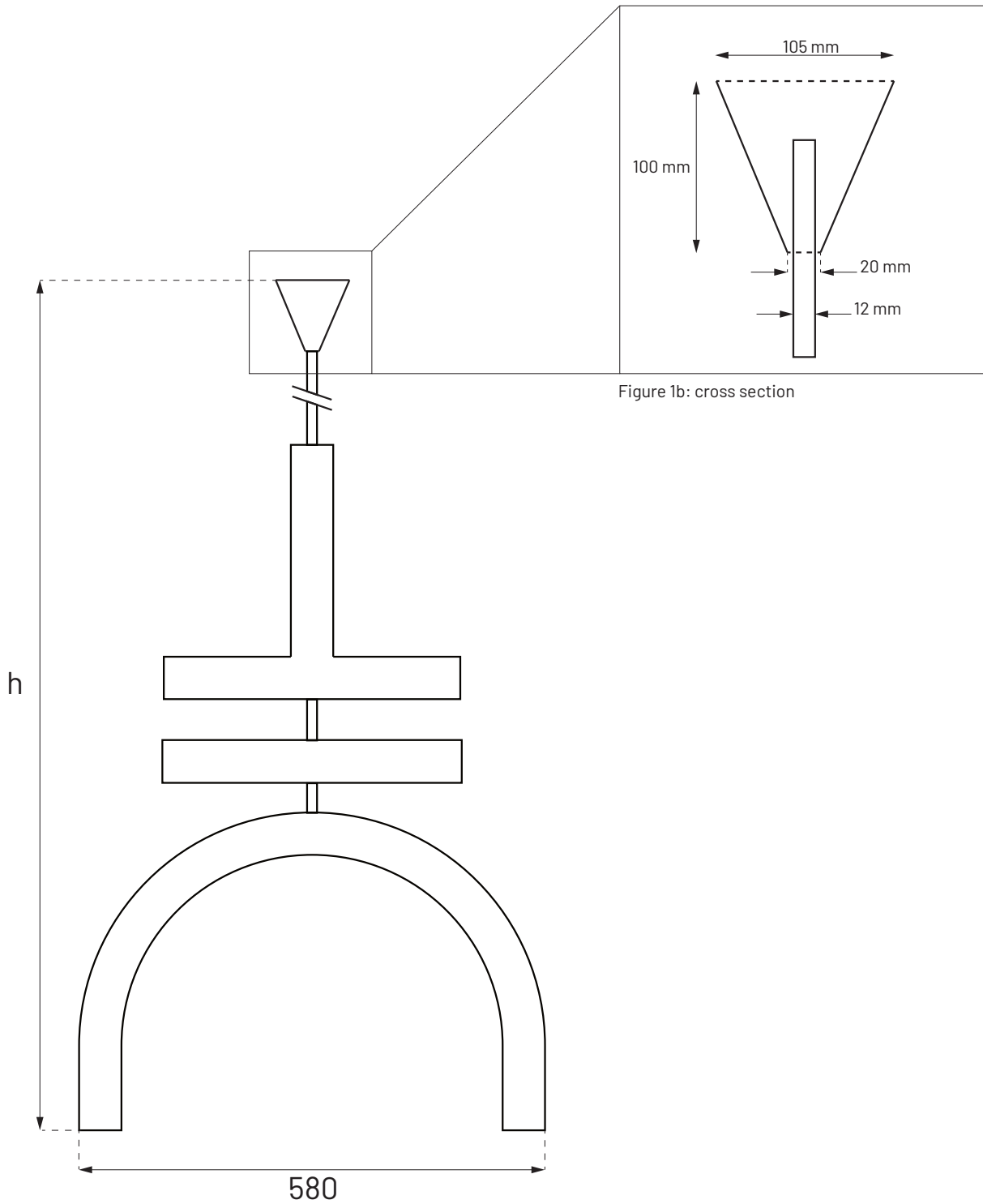

Figure 1: TRN dimensions

Technical specification

Materials:
ceramic, brass

Available product variations:
see page 4

Thread type:
E27

Maximum bulb wattage:
40W

Dedicated voltage:
220V/230V

Frequency:
50/60Hz

Working temperature:
to 40 °C

IP: 20

Comply with Directives:
2014/35/UE
2011/65/UE
PN-EN IEC 60598-1:2021-07E
PN-EN-60529:2003/A2:2014-07



Dimensions & Weight

Model	min. length / width / depth	weight
A1	430x160x50 mm / 16,93" x 6,30" x 1,97"	1 kg / 2,20 lbs
A2	300 x 360 x 50 mm / 11,81" x 14,17" x 1,97"	1 kg / 2,20 lbs
B1	480 x 360 x 50 mm / 18,90" x 14,17" x 1,97"	1 kg / 2,20 lbs
B2	530 x 360 x 50 mm / 20,86" x 14,17" x 1,97"	1 kg / 2,20 lbs
B3	430 x 360 x 50 mm / 16,93" x 14,17" x 1,97"	1 kg / 2,20 lbs
B4	630 x 580 x 50 mm / 24,80" x 22,84" x 1,97"	1,5 kg / 3,30 lbs
C1	430 x 360 x 50 mm / 16,93" x 14,17" x 1,97"	2 kg / 4,40 lbs
C2	830 x 360 x 50 mm / 32,68" x 14,17" x 1,97"	2 kg / 4,40 lbs
C3	600 x 360 x 50 mm / 23,62" x 14,17" x 1,97"	2 kg / 4,40 lbs
C4	480 x 360 x 50 mm / 18,9" x 14,17" x 1,97"	2 kg / 4,40 lbs
D1	600 x 360 x 50 mm / 23,62" x 14,17" x 1,97"	2,5 kg / 5,50 lbs
D2	430 x 360 x 50 mm / 16,93" x 14,17" x 1,97"	2,5 kg / 5,50 lbs
E1	630 x 580 x 50 mm / 24,8" x 22,84" x 1,97"	3 kg / 6,60 lbs
E2	950 x 580 x 50 mm / 37,40" x 22,84" x 1,97"	3 kg / 6,60 lbs
E3	540 x 580 x 50 mm / 26,38" x 22,84" x 1,97"	3 kg / 6,60 lbs
F1	600 x 580 x 50 mm / 23,62" x 22,84" x 1,97"	3,5 kg / 7,70 lbs
F2	1000 x 580 x 50 mm / 39,37" x 22,84" x 1,97"	3,5 kg / 7,70 lbs
F3	670 x 580 x 50 mm / 26,38" x 22,84" x 1,97"	3,5 kg / 7,70 lbs

Color variants*

glossy glazes



red



green



lilac



pistachio

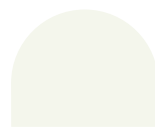

bone



ochre



brown



black



mellow yellow



cobalt



steel blue



denim blue



navy blue



pink

matt glazes

Metal finish variants



brass



silver-nickled
brass



black-nickled
brass

* Colors in reality may vary from those shown in the catalog due to the natural hand glazing process

TRN Lighting / Available models / Minimum Lengths

Our TRN lighting fixtures are designed to hang on a inflexible metal tube with a wire hidden inside. This allows the lamp to be mounted in a fixed position. However, it also means that the length of the lamp is not adjustable after installation. For this reason, we kindly ask you to specify the desired length when placing your order. The figure below indicates the minimum length of the lamps

A1

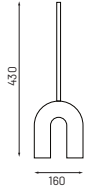

A2

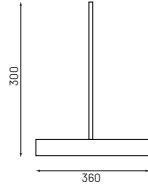

B1

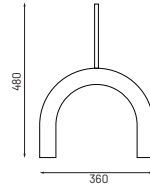

B2

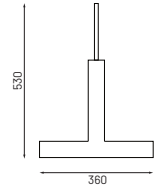

B3

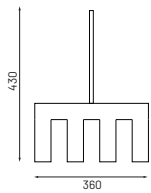

B4

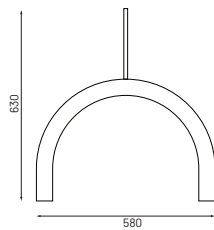

C1

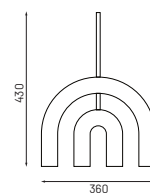

C2

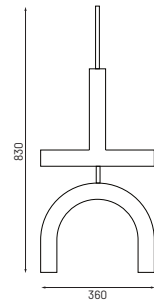

C3

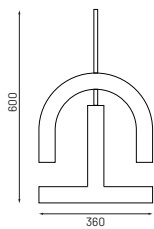

C4

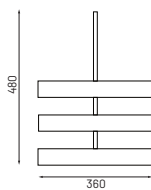

D1

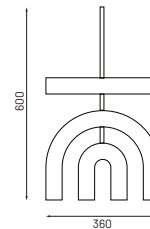

D2

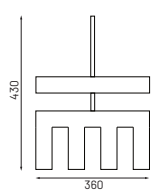

E1

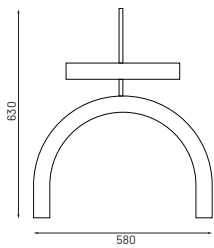

E2

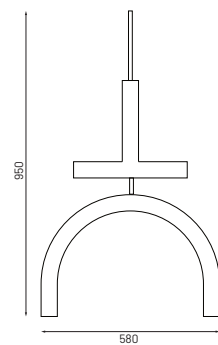

E3

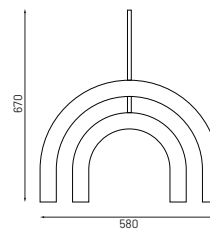

F1

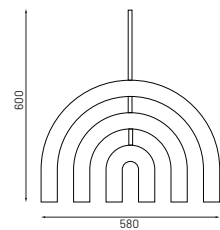

F2

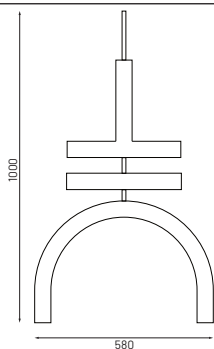

F3

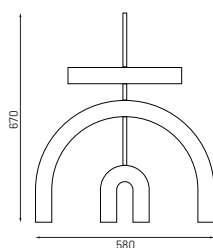

TRN Lighting / Available models / Ceramic Elements Dimensions

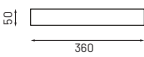
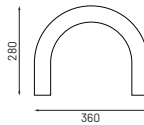
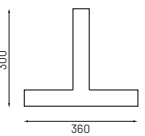
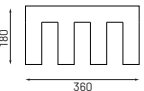
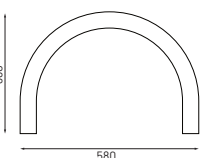
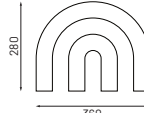
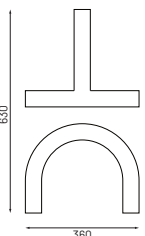
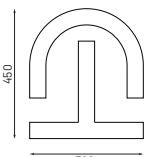
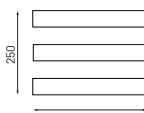
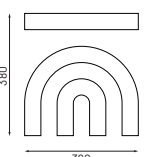
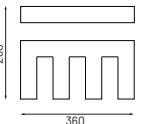
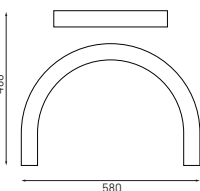
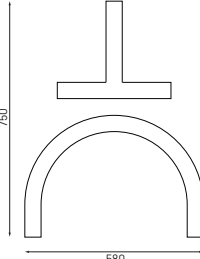
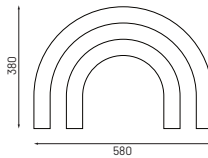
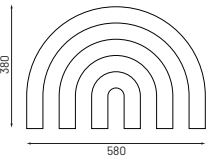
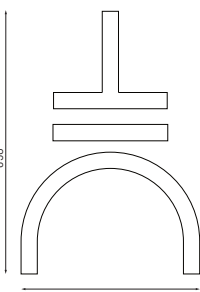
<p>A1</p> 	<p>A2</p> 	<p>B1</p> 	<p>B2</p> 
<p>B3</p> 	<p>B4</p> 	<p>C1</p> 	<p>C2</p> 
<p>C3</p> 	<p>C4</p> 	<p>D1</p> 	<p>D2</p> 
<p>E1</p> 	<p>E2</p> 	<p>E3</p> 	<p>F1</p> 
<p>F2</p> 	<p>F3</p> 